

Instruction Manual



Anderson Instrument Co., Inc.
156 Auriesville Rd.
Fultonville, NY 12072

Phone: 518-922-5315
800-833-0081

Fax: 518-922-8997

AV-9900 Field Setup Guide

Rev. 4.0

Doc. 1029

AV-9900
Microprocessor Based
HTST Recorder/Controller

Table of Contents

1. INTRODUCTION	3
2. KEY PRODUCT FEATURES.....	4
2.1. HOT PRODUCT TEMPERATURE SENSOR.....	4
2.2. DIVERSION SWITCHING	4
2.3. DIAGNOSTIC CIRCUITRY	4
2.4. PEN DRIVE MECHANISM AND CHART PRINTING.....	5
2.5. COLD PRODUCT RECORD - CONTROL	5
2.6. HOT WATER LOOP CONTROL	5
3. HARDWARE DESCRIPTIONS	6
3.1. CHART PLATE SEAL	6
3.2. SECURITY MODE SELECTION SHUNT.....	7
3.3. KEYPAD	8
4. USER DISPLAY	9
4.1. SETTING CONTINUOUS DISPLAY.....	9
4.2. SETTING SEQUENCE DISPLAY.....	9
5. PASTEURIZED MILK ORDINANCE (PMO) APPENDIX I TESTING.....	10
5.1. AV-9900 TESTING QUICK REFERENCE	10
5.2. METER BASED TIMING FUNCTION – CHART VERIFICATION	11
5.3. TESTS 2 AND 4 - TEMPERATURE ACCURACY	13
5.3.1. <i>Pen Calibration</i>	13
5.3.2. <i>Two Point Element Calibration</i>	14
5.3.3. <i>Chart Calibration</i>	17
5.4. TEST 3 - TIME ACCURACY	18
5.5. TEST 8 - THERMOMETRIC RESPONSE	18
5.6. TEST 10 - MILK TEMPERATURE AT CUT-IN AND CUT-OUT	18
5.7. TEST 11 – CONTINUOUS FLOW HOLDING TUBES – HOLDING TIME	19
5.7.1. <i>LED Indicators for “Loss of Signal” and “High Flow” Alarms</i>	19
5.7.2. <i>Accessing Flow Alarm Setpoints</i>	21
5.7.3. <i>Accessing Flow Controller Setpoint</i>	22
5.7.4. <i>Appendix I - Test 11.2A Mag Flow Meter Based Timing Systems Continuous Flow Holding Time</i>	23
5.7.5. <i>Appendix I - Test 11.2B Continuous Flow Holding Tubes – Flow alarm</i>	23
5.7.6. <i>Appendix I - Test 11.2C Continuous Flow Holding Tubes – Low Flow / Loss-of-Signal Alarm</i>	24
5.7.7. <i>Appendix I - Test 11.2D Continuous Flow Holding Tubes – Flow Cut-In and Cut-Out</i>	24
5.7.8. <i>Appendix I - Test 11.2E Continuous Flow Holding Tubes – Time Delay Relay</i>	25
5.8. TEST 15 – ELECTRO MAGNETIC INTERFERENCE FROM HAND-HELD COMMUNICATION DEVICES	26
6. DEFAULT PARAMETER VERIFICATION.....	27
6.1. STLR FUNCTION SETUP	27
6.2. STLR RECORDER SETUP	30
6.3. CHART SETUP.....	34
7. RUN MODE PARAMETER CHANGES	37
7.1. CHART KEY.....	37
7.2. DISPLAY KEY	38
7.3. SCROLL KEY	38

1. Introduction

The AV-9900 High Temperature Short Time Controller provides all USPHS required functions associated with recording pasteurized product temperature, signaling the flow diversion valve (F.D.V.), and recording the Flow Diversion Valve position. Additional features allow for multiple diversion set-points, recording active diversion setpoint, cold product recording - with optional control, and hot water control.

The remainder of this publication will serve as further introduction to the features of the AV-9900, as well outlining procedures necessary to perform the PMO Appendix I tests.

2. Key Product Features

The AV-9900 Microprocessor Based Safety Thermal Limit Recorder incorporates many time proven features found in earlier Anderson products. Ease of operation and high safety standards were brought together specifically to meet the demands of the pasteurization process. Key features of the AV-9900 are as follows:

2.1. Hot Product Temperature Sensor

The Hot Product Sensor is a dual element, 1000 ohm Resistance Temperature Detector (RTD). The Primary RTD supplies the recording - thermal limit signal input, with the Secondary RTD supplying a verification for that signal.

Sensors are available with a wide variety of sanitary connections featuring a 5-1/2" or 7-1/4" probe length. Provision for the *Health Authority Seal* on the stainless steel conduit housing provides separate servicing of the probe, and ease of installation. Overall response characteristics allow for cable runs of up to 500 feet.

Chart ranges are programmable, and are factory set to meet all Pasteurized Milk Ordinance (PMO) requirements. In addition, criteria of 12 hour rotation and 1°F divisions have been met.

2.2. Diversion Switching

Diversion set-point circuitry provides for up to five selectable cut-in/cut-out temperatures. User configurable parameters exist for displaying the active set-point. The current set-point is recorded to the chart for verification at time of cut-

in. Diversion set-point values are easily modifiable upon breaking the Health Authority Seal, and entering the system program mode. In addition to restricting access to the Run/Program shunt jumper, the chart plate seal also prevents modifications to circuit boards and input/output wiring connections.

Flow Diversion Valve position is indicated by red and green lights on the chart plate, in addition to being recorded by an event pen on the outside area of the chart. The event pen position is outward for forward flow on all diversion set-points. Selection of the current diversion set-point is accomplished via the front mounted user keypad and display. Five function keys become active, allowing the user to choose the desired set-point.

2.3. Diagnostic Circuitry

The AV-9900 provides fail-safe operation via internal self-diagnostics of the Hot Product Probe input signals. The Primary RTD input signal is continually referenced against the Secondary RTD signal. The result is indicated on a series of LED's, located just above the user display, and labeled *Sensor Balance*. If both RTD elements are in agreement by less than .5 °F, no LED's are lit. Each increment of .5°F shift will light an LED. At the point at which the elements differ greater than 2°F, the AV-9900 will go into automatic divert. In addition, the user display will indicate that a *Probe Failure* has taken place. Until a replacement Hot Product Probe is installed, the unit will not allow a forward flow condition to take place.

2.4. Pen Drive Mechanism and Chart Printing

The pen drive mechanism is similar to a dot-matrix print device in that a series of dots are placed down onto the paper chart. This mechanism is fully alpha-numeric capable, allowing printing of ranges, units, alarm's, etc. to the chart. All four pens are housed within a small pen cartridge, in a straight line arrangement. As a result, all data printed to the chart is on the same time line. No lag exists from pen to pen as with typical felt pen type recorders. Chart ranges and scales are factory programmed, per applicable PMO requirements, but may easily be re-ranged in the field. Charts are plain paper, and pre-printed only with circular ring divisions. Division spacing meets PMO requirements. User defined scales and chart ranges are printed in one of four available colors.

2.5. Cold Product Record - Control

The AV-9900 may be configured to receive an input from an RTD, or mA transmitter, measuring the Cold Product temperature as it exits the pasteurization loop. This function may be specified at time of order, or upgraded in the field at a later date. A factory set, field modifiable scale has been programmed for the recording pen. Data will be recorded in color allowing easy interpretation when reviewing chart information.

An additional option exists for controlling the Cold Product Cooling within the AV-9900. An optional PID Loop Control function can be specified at time of order, or upgraded at a later date in the field. This function will receive its input from the same probe measuring the Cold Product temperature. In turn, a desired set-point may be programmed, with output signals interfacing to the cooling loop. The PID, or control functions, will vary the resulting output signal based on rising above or falling below the desired Cold Product set-point.

2.6. Hot Water Loop Control

The AV-9900 may be configured to receive an input from an RTD, or mA transmitter, measuring the Hot Water Loop temperature. This function may be specified at time of order, or upgraded in the field at a later date. In turn, a desired set-point may be programmed, with output signals interfacing to the Hot Water Loop. The PID, or control functions, will vary the resulting output signal based on rising above or falling below the desired Hot Water set-point.

If various products are being processed, up to five Hot Water Controllers are available (one for each STLR diversion set-point). Each controller may have it's own set-point and PID tuning parameters. When the operator selects a new STLR diversion set-point, the corresponding Hot Water Controller is automatically selected. Again, Hot Water Control set-points and PID tuning parameters would have been pre-programmed

3. Hardware Descriptions

In performing the required testing, access will be made to various areas of the AV-9900 hardware. Specifics are illustrated as follows:

3.1. Chart Plate Seal

Provisions have been provided for placing the Regulatory Wire Seal in the upper right corner of the chart plate. When in place, this seal prevents unauthorized access to not only the internal wiring, but also access to the Security Mode Shunt (see next section).

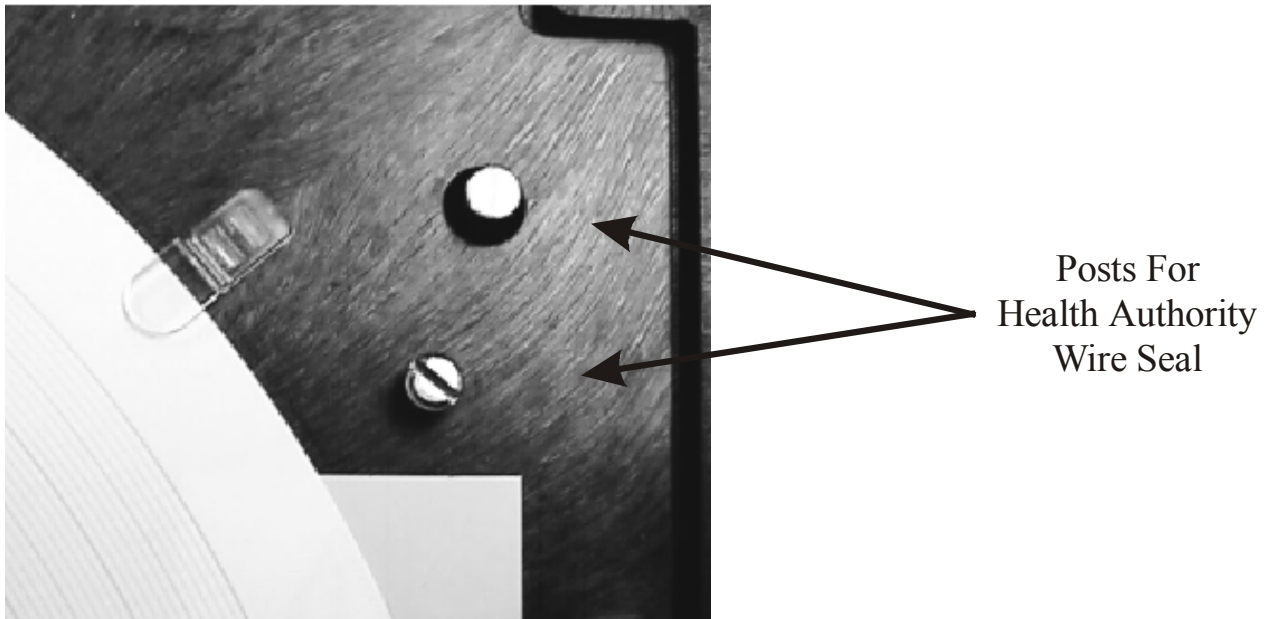

3.2. Security Mode Selection Shunt

The AV-9900 is equipped with a movable shunt to allow toggling between RUN and PROGRAM modes of operation. While in RUN mode, access is prevented to all system critical parameters (ranges, setpoint changes, etc.). Changes may be made to display functions as well as selection of the currently active diversion setpoint. While in PROGRAM mode, full access to all system parameters is allowed.





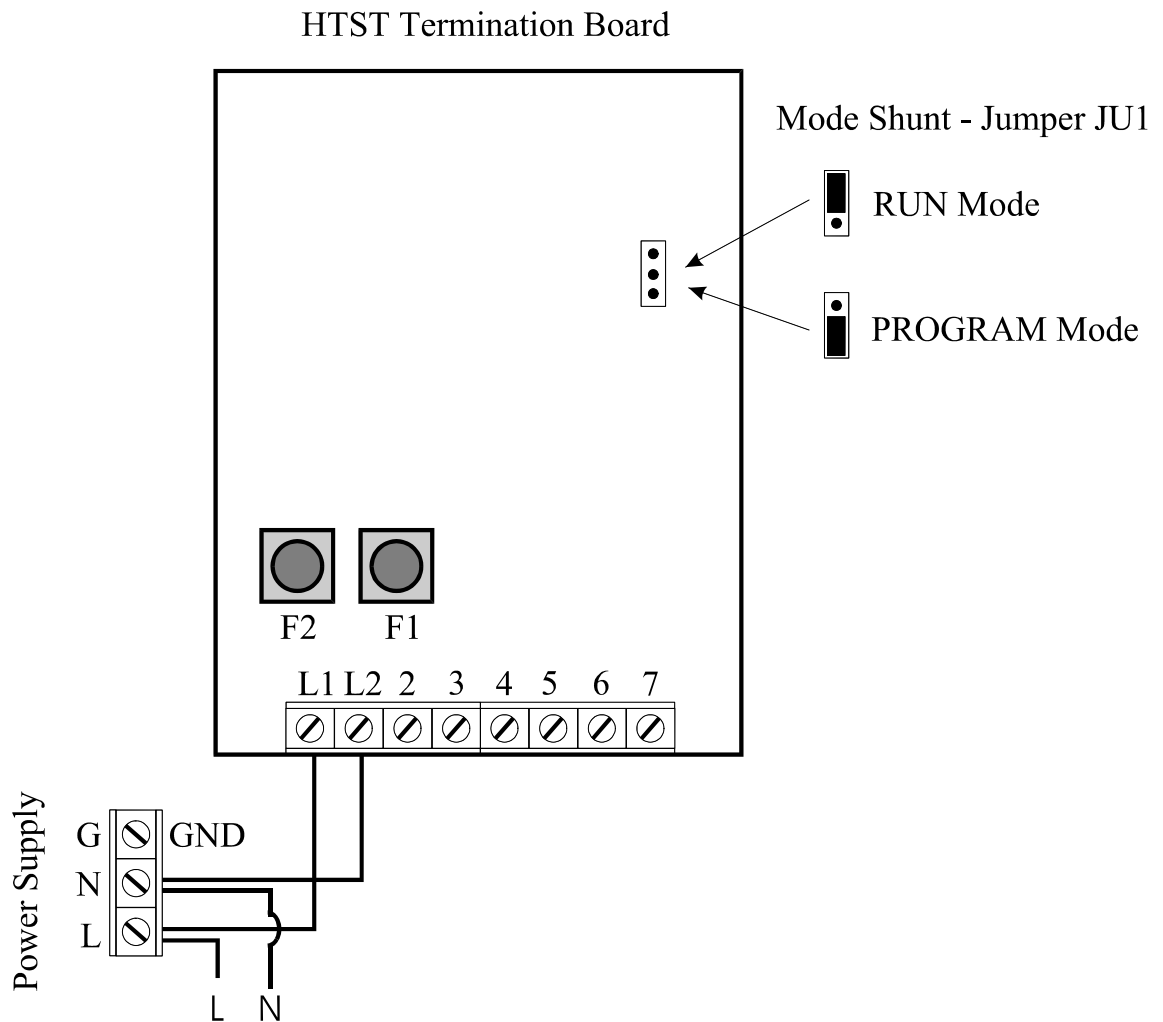





NOTE: Moving the Security Mode Selection Shunt to the PROGRAM position will *immediately* force the unit to DIVERT flow. If already in DIVERT flow, the unit will remain in that mode even if the hot product temperature rises above the active setpoint.

The following diagram illustrates the location of the Security Mode Selection Shunt, in addition to the settings, RUN or PROGRAM.



3.3. Keypad

Located on the front chart plate of the unit is the USER KEYPAD. From here, access to the program parameters can be gained. A description of each of the keys is as follows:

	UP ARROW	Used to move through menus, or increase a value
	DOWN ARROW	Used to move through menus, or decrease a value
	LEFT ARROW	Used to move through menus or digits of a parameter
	SCROLL (RIGHT ARROW)	Used to move through menus or digits of a parameter
	ESCAPE	Used to cancel a flashing program prompt
	RESET	Jump from within programming menus to the standard operating screen
	DISPLAY	While in display RUN mode allows access to STLR diversion setpoints as well as display viewing option parameters
	MODIFY	Allows changes to be made to a currently displayed parameter
	CHART	Allows access to the <i>Change Chart Routines</i>
	ENTER	Locks in changes made to a parameter







4. User Display

Also located on the front chart plate is the User Display. From here, data such as a digital readout of the STLR temperature value may be viewed. This display will be utilized in selected areas of the Pasteurized Milk Ordinance Appendix I testing.







Two options exist for the display; CONTINUOUS DISPLAY and SEQUENCE DISPLAY. When in continuous mode, the selected parameter is viewable at all times on the display. This is the required mode for completion of the Appendix I testing. While in sequence mode, various parameters scroll over the screen at a timed interval.

If the unit is set to SEQUENCE display mode, the following procedure will allow the unit to be placed in continuous mode, with the STLR temperature visible:

4.1. Setting CONTINUOUS Display

1. Operation may be done with Security Mode Shunt in either position - no changes required.
2. Press  key twice - you will see: 
3. Press the  key once.
4. If CONTINUOUS is not already flashing, press the  key.
5. With CONTINUOUS flashing, press the  key once.
6. Press the  key once to return to the main display.
7. Press  until STLR INP is displayed - this is the digital display of Hot Product Temperature.
8. You may now complete the required testing.

4.2. Setting SEQUENCE Display

1. To return the display to SEQUENCE mode, proceed as follows:
2. Operation may be done with Security Mode Shunt in either position - no changes required.
3. Press  key twice - you will see: 
4. Press the  key once.
5. If SEQUENCE is not already flashing, press the  key.
6. With SEQUENCE flashing, press the  key once.
7. Press the  key once to return to the main display.
8. The unit is now back in standard operation.

5. Pasteurized Milk Ordinance (PMO) Appendix I Testing

This section will provide specific procedures regarding the completion of the PMO Appendix I tests. Only AV-9900 specific information has been provided. For a detailed listing of the actual testing procedure, please refer to the Pasteurized Milk Ordinance, Appendix I.

5.1. AV-9900 Testing Quick Reference

Test	Description	Variance From Printed PMO Appendix I Test
2	Recording Thermometers – Temperature Accuracy	Pen printing not instantaneous – utilize display for test
3	Recording Thermometers – Time Accuracy	Test to be started when AV-9900 prints a Major (bold) time line, and ended when thirty minute dashed line printed
4	Recording Thermometers – Check Against Indicating Thermometer	Pen printing not instantaneous – utilize display for test
8	Recorder/Controller – Thermometric Response	Pen printing not instantaneous – utilize display for test
10.1	Milk-Flow Controls – Milk Temperature at Cut-In and Cut-Out; HTST Pasteurizers	Pen printing not instantaneous – utilize display for test
10.2	Milk-Flow Controls – Milk Temperature at Cut-In and Cut-Out; HHST Pasteurizers and Aseptic Processing Systems Using Indirect Heating	Pen printing not instantaneous – utilize display for test
10.3	Milk-Flow Controls – Milk Temperature at Cut-In and Cut-Out; HHST Pasteurizers and Aseptic Processing Systems Using Direct Heating	Pen printing not instantaneous – utilize display for test
11.1	Continuous Flow Holding Tubes – Holding Time – HTST Pasteurizers	None – complete test as documented
11.2-A	Magnetic Flow Meter Based Timing Systems Continuous Flow Holding Time	Pen printing not instantaneous – utilize display LEDs’ #1 and #2 for test
11.2-B	Continuous Flow Holding Tubes – Flow alarm	Flow rate must be adjusted to go past High Flow Setpoint. Cannot adjust High Flow Setpoint in RUN mode as required by standard PMO test.
11.2-C	Continuous Flow Holding Tubes – Low Flow / Loss-of-Signal Alarm	Pen printing not instantaneous – utilize display LEDs’ #1 and #2 for test
11.2-D	Continuous Flow Holding Tubes – Flow Cut-In and Cut-Out	Pen printing not instantaneous – utilize display LEDs’ #1 and #2 for test
11.2-E	Continuous Flow Holding Tubes – Time Delay Relay	Pen printing not instantaneous – utilize display LEDs’ #1 and #2 for test
15	Electro Magnetic Interference From Hand-Held Communication Devices	None – complete test as documented

5.2. Meter Based Timing Function – Chart Verification





Prior to completing tests, a check should be made to verify that the chart is properly programmed to show the FLOW portion on the first 40 units of the chart. This configuration is REQUIRED. Procedure is as follows:

1. Unit MUST be in PROGRAM mode – see Section 3.2

2. Press the  key until the display shows:

**SELECT
CONFIGURATION** <->

3. Press the  key.

4. Press the  key until the display shows:

**CONFIGURE
RECORDING PENS** <->

5. Press the  key.

6. Press the  key until the display shows:

**RECORDING FUNCTION
SFLR INPUT/EVENT**

7. Press  key once.

8. Press the  key until the display shows:

**SFLR INP ZONE LOW
DIVISION X**

9. Verify that DIVISION “0” is programmed.

10. Use the  key along with   keys to make a change if necessary.

11. Press the  key until the display shows:

**SFLR INP ZONE HIGH
DIVISION X**

12. Verify that DIVISION “40” is programmed.

13. Use the  key along with   keys to make a change if necessary.

14. Press the  key until the display shows:

**SFLR INP ZONE LOW
VALUE X**

15. Verify that VALUE “0” is programmed.

16. Use the **MOD** key along with **↑** **↓** keys to make a change if necessary.

17. Press the **☰** key until the display shows:

**SFLR INP ZONE HIGH
VALUE X**

18. Verify that VALUE equivalent to the full scale output of the Flow Meter is programmed.

19. An example would be a meter that outputs 4.00 mA at 0 GPM flowrate, and 20.00 mA at 464 GPM flowrate. The proper value to be entered into the ZONE HIGH VALUE would be 464. This value may be obtained from the individual that commissioned the flow meter.

20. Use the **MOD** key along with **↑** **↓** keys to make a change if necessary.

21. Press the **RESET** key to return to the main display.

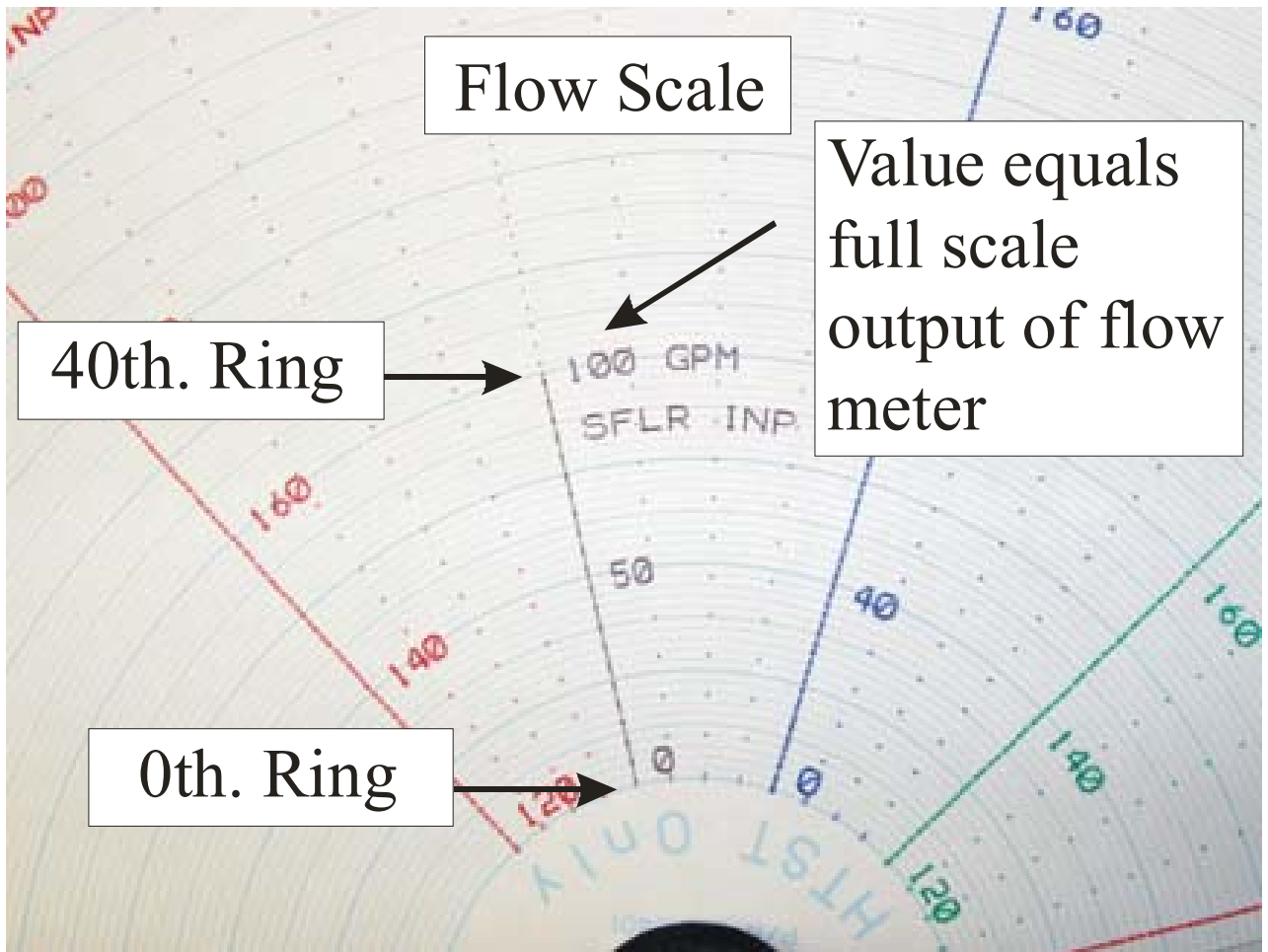

5.3. Tests 2 and 4 - Temperature Accuracy

The AV-9900 provides two means for calibrating the instrument to match the indicating (reference) thermometer. Both procedures require the unit to be in PROGRAM MODE of operation.



Prior to completing tests, a check should be made to verify that PEN and DISPLAY are in agreement. If any discrepancy is present, a CHART CALIBRATION should be completed. See section 5.2.3 for details on this procedure.

The first section describes a single point calibration to bring the pen AND display into agreement with the indicating thermometer at or near the normal operating temperature. This adjustment is typically used to remove minor discrepancies between the AV-9900 and the Reference Thermometer. It is also often used during initial startup to offset the pen so it tracks slightly lower than the indicating thermometer (0.5°F typical).

The second section describes the Two Point Calibration procedure which mimics a complete “factory” calibration. This procedure is typically performed at one year service intervals, or at the time of Hot Product Sensor replacement.

5.3.1. Pen Calibration

The AV-9900 allows for fine tuning of the Pen and Display. This will allow removal of minor discrepancies between the 9900 and the reference thermometer. In addition, an offset (0.5°F typical) may be established so that the 9900 will display and record slightly less than the indicating thermometer.

22. After testing the accuracy using the PMO procedure, any discrepancy between the AV-9900 **RECORDING PEN/DISPLAY**, and the indicating thermometer, may be adjusted by the remainder of this procedure.

23. Unit **MUST** be in PROGRAM mode – see Section 3.2

24. Press the  key until the display shows:

**SELECT
FUNCTION SETUP** <->

25. Press the  key.

26. Press  key if STLR is not flashing (Multiple function units only – Skip if ONLY STLR shows on the display)

27. Press the  key once.





28. Press the  key until the display shows:

**STLR INP CORRECTION
.0 °F (or C)**

29.









30. Press  key once.







31. Cursor will appear under left most numeral.

32. Use   keys to make a change - this is desired amount of correction to the PEN.
33. When adjustment is complete, press the  key once.
34. Press the  key to return to the main display.
35. If the unit has been moved from SEQUENCE display to CONTINUOUS display for this test, it may be reset at this point.
36. Follow standard temperature test practices to verify adjustments.

5.3.2. Two Point Element Calibration

The following procedure will allow the STLR Hot Product Input Sensor to be calibrated in accordance with the verified indicating thermometer. This procedure will also allow the dual 1000 ohm STLR sensor input to be properly balanced. During this test, we will be concerned with the temperature being shown on the AV-9900 **DISPLAY ONLY**.







1. As described in section 4.1, the AV-9900 display should now be in CONTINUOUS DISPLAY mode, and showing the STLR INP value (Hot product temperature)
2. After testing the accuracy using the PMO procedure, any discrepancy between the AV-9900 STLR INP value shown on the display, and the indicating thermometer, may be adjusted by the remainder of this procedure.
3. Break chart plate seal to gain access to internal wiring (Section 3.1).
4. Using Section 3.2 as a reference, locate the **Security Mode Shunt** on the HTST termination board.
5. Place the security shunt in the program position.
6. Press  key until **FUNCTION SETUP** is visible on front display.
7. Press  key once.
8. Press  key until **STLR** is **FLASHING** on display.
9. Press  key once.
10. Press  key until **INPUT DISPLAY BOTH – NO** is visible on display.
11. Press  key once.
12. Press  key until **YES** is **FLASHING** on display.
13. Press  key once.
14. Press  key until **STLR INP 1** and **STLR INP 2** are both visible on display.

15. Recommended calibration temperatures for 120°F to 220°F chart would be 150°F for low end bath, and at least as high as high diversion setpoint for high end bath.
16. Place Indicating Thermometer, Verified Reference Thermometer, and STLR probe in regulated low end bath.
17. Verify that Indicating Thermometer matches Reference Thermometer.
18. Via display on front of AV-9900, note STLR INP 1 and STLR INP 2 temperature readings.
19. If an adjustment is needed to either STLR INP 1 or STLR INP 2 temperatures, proceed as follows. If Ok, move to high end bath (step 37) and repeat test.
20. Press  key until **CONFIGURATION** is visible on front display.
21. Press  key once.
22. Press  key until **INPUTS** is visible on front display.
23. Press  key once.
24. Press  key until **STLR** is **FLASHING** on front display.
25. Press  key once.
26. Press  key until the following is visible on display:
27. Use following example to determine change:

STLR INPUT 1 CORR 1
.0 AT .0

Reference indicates 150°F at actual 150°F
 AV-9900 indicates 151°F at actual 150°F

Correction will be: -1.0 AT 151.0

28. Press  key once.
29. Cursor will appear under left most numeral.
30. Use   keys to make a change - this is desired amount of correction.
 (-1.0 for example)
31. Hit  key once.
32. Use   keys to make a change - this is desired point at which to make correction. (151.0 for example)
33. Hit  key once.

34. Press  key until the following is visible on display:

**STLR INPUT 2 CORR 1
.0 AT .0**

35. Follow steps 28 through 33, entering the necessary correction values for STLR INP 2.

36. Hit  key once.

37. Raise bath temperature to high end.

38. Via display on front of AV-9900, note STLR INP 1 & 2 temperature readings.

39. If an adjustment is needed to either STLR INP 1 or STLR INP 2 temperatures, proceed as follows. If Ok, move to step 56.

40. Press  key until **CONFIGURATION** is visible on front display.

41. Press  key once.

42. Press  key until **INPUTS** is visible on front display.

43. Press  key once.

44. Press  key until **STLR** is **FLASHING** on front display.

45. Press  key once.

46. Press  key until the following is visible on display:

**STLR INPUT 1 CORR 2
.0 AT 100.0**

47. Use following example to determine change:



Reference indicates 200.0°F at actual 200.0°F

AV-9900 indicates 200.5°F at actual 200.0°F



Correction will be: -.5 AT 200.5

48. Press  key once.

49. Cursor will appear under left most numeral.

50. Use   keys to make a change - this is desired amount of correction. (-.5 for example)

51. Hit  key once.

52. Use   keys to make a change - this is desired point at which to make correction. (200.5 for example)

53. Hit  key once.

54. Press  key until the following is visible on display:

**STLR INPUT 2 CORR 2
.0 AT 100.0**

55. Follow steps 48 through 53, entering the necessary correction values for STLR INP 2.

56. Hit  key once.

57. Two point calibration is now complete. The unit calibration may be verified via temperature bath testing, with additional correction made if required.

5.3.3. Chart Calibration

1. Unit MUST be in PROGRAM mode – see Section 3.2

2. Press the  key until the display shows:

**SELECT
CALIBRATION** 

3. Press the  key.



4. Press the  key until the display shows:





**CALIBRATION
CHART CALIBRATION** 

5. Press the  key.

6. Press  key once.

7. Press the function key under YES to start chart calibration – be sure a paper chart is in proper recording position.

8. Press the  key “3” times – a dot will be printed near the innermost ring of the chart. If the dot is NOT directly on the FIRST chart ring, use the   to make a change in position.

9. Once properly aligned to the innermost ring, press the  key ONCE to begin calibrating the outer pen position. Press the  key once to print a dot near the outer most ring. If the dot is NOT directly on the 100th chart ring, use the   to make a change in position.
10. Once complete, press  key once to save new calibration.

5.4. Test 3 - Time Accuracy

With the unit in RUN mode and while the chart is printing, use an accurate watch to test for time accuracy as follows:

1. Begin timing when the unit prints a MAJOR TIME LINE (solid color).
2. Stop timing when the mechanism prints the SECOND minor time line (second dotted line). The elapsed time should be 30 minutes.

5.5. Test 8 - Thermometric Response

The standard testing procedure, as described in the Pasteurized Milk Ordinance, may be used with the exception that the display must be utilized to start the stopwatch at the proper temperature. If the display is currently set to SEQUENCE mode, refer to section 4 to place the display into CONTINUOUS mode.

The display will now show the current STLR INP temperature (hot product temperature), as well as the an indication that the unit is above or below the diversion setpoint STLR OUT (OFF or ON).

To properly test for response time, simply start the stopwatch when the display reads a temperature 12 degrees below the cut-in temperature. If the display moves to quickly or skips over the desired start temperature, you may start the watch at a temperature 2-3 degrees below the desired temperature. The resulting test data should still be well within the 5 second maximum. Stop the watch when the display changes from:

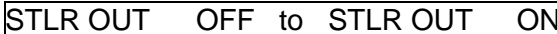

5.6. Test 10 - Milk Temperature at Cut-in and Cut-out













The standard testing procedure, as described in the Pasteurized Milk Ordinance, may be used with the exception that the display must be utilized to verify the proper cut-in / cut-out temperature.

To select a new pre-programmed diversion setpoint, proceed as follows:

1. From the main display, press the  key once.
2. All currently programmed diversion setpoints will now be displayed.
3. Each value will be above a FUNCTION KEY.
4. Press the key just under the desired value to activate the new diversion setpoint.

If a change is required to the Cut-out temperature or to the amount of dead-band between Cut-in and Cut-out, proceed as follows:

1. Be sure that the unit is in PROGRAM MODE (Section 3.2).
2. Press the  key until the display shows:

SELECT CONTROLLER SETUP	<->
------------------------------------	------------------
3. Press the  key once.
4. If STLR is not already flashing, press the  key (Multiple function units only – Skip if STLR only showing).
5. Press the  key once.
6. Press the  key until the desired diversion setpoint is visible.
7. If you pass by the setpoint, use the  key to move backward.
8. Using the keys  and  you can view each of the diversion setpoints, and their associated dead-band value.
9. To modify a value, press the  key once.
10. Use the   keys to make the change.
11. Press the  key when satisfied with the change.
12. When done making changes, press the  key to return to the main display.

5.7. Test 11 – Continuous Flow Holding Tubes – Holding Time

PMO test 11 covers methods used to determine hold time of various system configurations. For AV-9900 systems integrating the Safety Flow Limit Record function (Meter Based Timing), additional details have been provided to assist in completing the required testing.

5.7.1. LED Indicators for “Loss of Signal” and “High Flow” Alarms

For AV-9900 systems integrating the SFLR function, mechanical relays have been interfaced with the Flow Diversion Device control unit. As the AV-9900 even pen printing is not “real time” print, LED indicators have been provided to give instantaneous feedback as to the position of the Loss of Signal and High Flow alarm and associated relay position. They are located above the main user display, and are set as follows:

LED Number 1 – Tied to Loss of Signal (Low Flow) alarm / relay point

LED Number 2 – Tied to High Flow alarm / relay point

Prior to completing tests in this section, proper programming of the LED’s will need to be verified. Complete procedure is as follows:

1. AV-9900 will need to be in PROGRAM mode – see Section 3.2 of this publication.
2. Press the  key until display shows:

SELECT CONFIGURATION	<->
---------------------------------	------------------
3. Press the  key once.





4. Press the  key until display shows:

**CONFIGURE
LEDS** <->

5. Press the  key once.





6. Press the  key until display shows:

**LED 1 ACTUATOR
SFLR ALARM 1** <->

7. If display does not show “SFLR ALARM 1,” setting is incorrect. Use the  and   arrow keys to make necessary changes;  key to accept change

8. Press the  key until display shows:

**LED 2 ACTUATOR
SFLR ALARM 2** <->

9. If display does not show “SFLR ALARM 2,” setting is incorrect. Use the  and   arrow keys to make necessary changes;  key to accept change

10. When done making changes, press the  key to return to the main display.

As indicated, the LED's are tied directly to the action of the Loss of Signal and High Flow alarms and relays. The following illustration shows proper operation of the flow alarms:

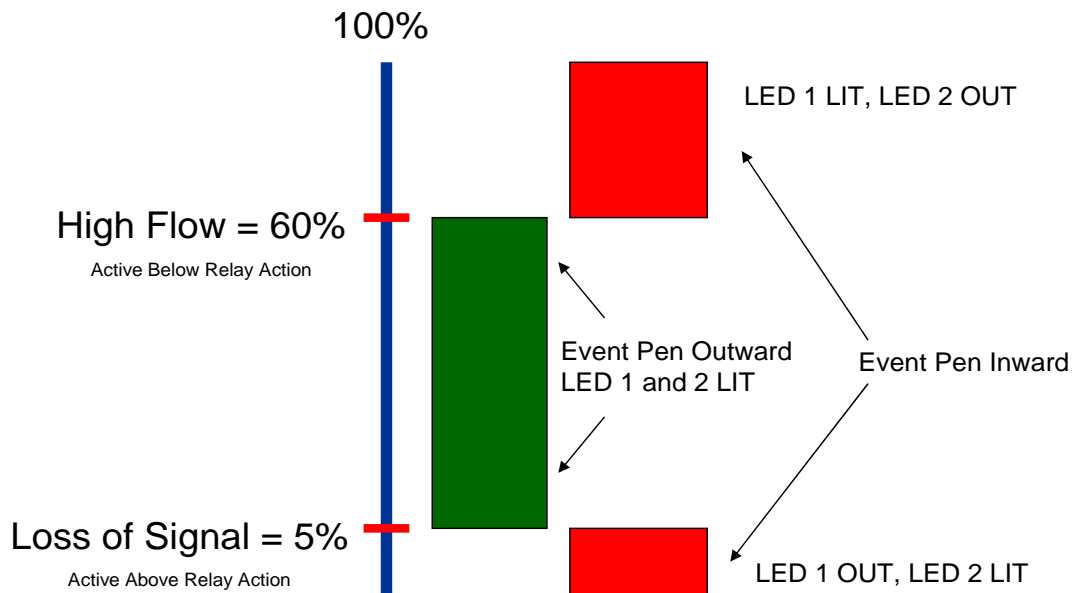



Percentages shown for illustration purposes only. Actual field units may be programmed in %, or actual units.



5.7.2. Accessing Flow Alarm Setpoints





The following procedure provides details for accessing the AV-9900 Flow Alarm Setpoints. These setpoints correspond to the Loss of Signal and High Flow alarms. In performing Appendix I Part 11 tests, these values may need to be modified.







Be sure to record original values present, and to re-program after completing required testing.

1. AV-9900 will need to be in PROGRAM mode – see Section 3.2 of this publication.
2. Press the  key until display shows:

**SELECT
FUNCTION SETUP** <->
3. Press the  key once.
4. Select “SFLR” function.
5. Press the  key until display shows:

**SFLR ALARM1 SETPOINT
XX.XX UNITS**
6. Alarm 1 represents the Loss of Signal setpoint
7. Use the  and   arrow keys to make necessary changes;  key to accept change.
8. Press the  key until display shows:

**SFLR ALARM2 SETPOINT
XX.XX UNITS**
9. Alarm 2 represents the High Flow setpoint
10. Use the  and   arrow keys to make necessary changes;  key to accept change
11. When done making changes, press the  key to return to the main display.











5.7.3. Accessing Flow Controller Setpoint

Systems utilizing Meter Based Timing have a means to slow down or speed up the metering pump. From here, the desired operating flow rate may be adjusted faster or slower. This control function may or may not be present in the AV-9900.

Prior to testing, be sure to ask the operator where the speed of the MBT pump is adjusted. Options are as follows:

- Via stand alone loop controller
- Via plant control system – panel or touch control screen
- Via loop controller integrated into AV-9900

If the pump speed is adjusted via control integrated into the AV-9900, adjustments to the operating flow rate may be made as follows:

1. Press the  key until display shows: 
2. Press the  key once.
3. Press the  key until display shows: 
4. Use the  and   arrow keys to make necessary changes;  key to accept change.
5. When done making changes, press the  key to return to the main display.

**5.7.4. Appendix I - Test 11.2A
Mag Flow Meter Based Timing Systems Continuous Flow Holding Time**

Special Requirements

- This test may be performed without any additional changes or additions to the procedure as published in the Pasteurized Milk Ordinance.

Notes:

- This test requires changes that be made to the High Flow Alarm
 - For AV-9900 specific instructions, refer to section 5.6.2 of this publication for instructions on how to modify this parameter.
- This test requires changes be made to the flow rate of the process.
 - Determine from operator where changes to flow rate are made.
 - IF flow rate is adjusted via control integrated within the AV-9900, refer to section 5.6.3 of this publication for instructions on how to modify this parameter.



**5.7.5. Appendix I - Test 11.2B
Continuous Flow Holding Tubes – Flow alarm**

Special Requirements

- This test differs slightly from the standard procedure as published in the Pasteurized Milk Ordinance.
- Published procedures require the High Flow Alarm Setpoint to be lowered until a point is reached whereas a divert is caused. In order to make this change in the AV-9900, the Run / Program switch must be in the Program mode. In Program, the AV-9900 will not allow a forward flow condition to occur, and forces a divert in all cases.
- For the purpose of this test, the SFLR controller will be utilized in order to ramp down the flow rate instead of lowering the High Flow Alarm Setpoint until it goes below the current flow rate.

Notes:

- This test requires changes that be made to the High Flow Alarm
 - For AV-9900 specific instructions, refer to section 5.6.2 of this publication for instructions on how to modify this parameter.
- This test requires changes be made to the flow rate of the process.
 - Determine from operator where changes to flow rate are made.
 - IF flow rate is adjusted via control integrated within the AV-9900, refer to section 5.6.3 of this publication for instructions on how to modify this parameter.
- In order to complete the test, the User Display as well as Flow Alarm LED's may be utilized.

1. Press the   keys until display shows:



STLR INP	XXX.X
STLR OUT	ON

2. Also, LED's #1 and #2 directly above the user display will be lit with flow rate above Loss of Signal and below High Flow.
- Once FORWARD or DIVERT flow is achieved, you will observe the FDD as well as the AV-9900 user display and status LED's shift. In addition, on the next print cycle of the pen, you can verify that the STLR and SFLR event pens shifted.

**5.7.6. Appendix I - Test 11.2C
Continuous Flow Holding Tubes – Low Flow / Loss-of-Signal Alarm**

Special Requirements

- This test requires viewing the movement of the FDD in conjunction with the STLR and SFLR event pens on the perimeter of the chart. Although event capture is performed immediately, data is not printed to the chart instantaneously.
- In order to complete the test, the User Display as well as Flow Alarm LED's may be utilized.

3. Press the   keys until display shows:

STLR INP	XXX.X
STLR OUT	ON

4. Also, LED's #1 and #2 directly above the user display will be lit with flow rate above Loss of Signal and below High Flow.
- As instructed in the Appendix I test, the power to the meter is disrupted, or the flow rate is lowered to a rate below the Loss of Signal alarm point. Once achieved, you will observe the FDD as well as the AV-9900 user display and status LED's shift. In addition, on the next print cycle of the pen, you can verify that the STLR and SFLR event pens shifted.

**5.7.7. Appendix I - Test 11.2D
Continuous Flow Holding Tubes – Flow Cut-In and Cut-Out**

Special Requirements

- This test requires viewing the movement of the FDD in conjunction with the STLR and SFLR event pens on the perimeter of the chart. Although event capture is performed immediately, data is not printed to the chart instantaneously.
- In order to complete the test, the User Display as well as Flow Alarm LED's may be utilized.

5. Press the   keys until display shows:

STLR INP	XXX.X
STLR OUT	ON

6. Also, LED's #1 and #2 directly above the user display will be lit with flow rate above Loss of Signal and below High Flow.



Notes:

- This test may requires changes that be made to the Loss of Signal and High Flow alarm values
 - For AV-9900 specific instructions, refer to section 5.6.2 of this publication for instructions on how to modify these parameters.
- This test requires changes be made to the flow rate of the process.
 - Determine from operator where changes to flow rate are made.
 - IF flow rate is adjusted via control integrated within the AV-9900, refer to section 5.6.3 of this publication for instructions on how to modify this parameter.
- Once FORWARD or DIVERT flow is achieved, you will observe the FDD as well as the AV-9900 user display and status LED's shift. In addition, on the next print cycle of the pen, you can verify that the STLR and SFLR event pens shifted.

**5.7.8. Appendix I - Test 11.2E
Continuous Flow Holding Tubes – Time Delay Relay**

Special Requirements

- This test requires viewing the movement of the FDD in conjunction with the STLR and SFLR event pens on the perimeter of the chart. Although event capture is performed immediately, data is not printed to the chart instantaneously.
- In order to complete the test, the User Display as well as Flow Alarm LED's may be utilized.

7. Press the   keys until display shows:

STLR INP	XXX.X
STLR OUT	ON

8. Also, LED's #1 and #2 directly above the user display will be lit with flow rate above Loss of Signal and below High Flow.

Notes:

- This test requires changes be made to the flow rate of the process.
 - Determine from operator where changes to flow rate are made.
 - IF flow rate is adjusted via control integrated within the AV-9900, refer to section 5.6.3 of this publication for instructions on how to modify this parameter.
- Once FORWARD or DIVERT flow is achieved, you will observe the FDD as well as the AV-9900 user display and status LED's shift. In addition, on the next print cycle of the pen, you can verify that the STLR and SFLR event pens shifted.

5.8. Test 15 – Electro Magnetic Interference From Hand-Held Communication Devices

Special Requirements

- No special requirements exist for this test. Procedures as outlined in the Pasteurized milk ordinance may be completed as published.

If the display was moved from SEQUENCE to CONTINUOUS, refer to Section 4 for detailed instructions to switch modes. When completed with all testing and verification, the Security Mode Shunt should be placed back into the RUN position as shown in Section 3.2. Lastly, the Health Authority Seal should be attached as per Section 3.1.

6. Default Parameter Verification

The following section will illustrate the STLR specific parameters which may be reviewed. These parameters are categorized as critical to proper unit function and or Pasteurized Milk Ordinance compliance.

6.1. STLR Function Setup



Note: See section 3.2 to set unit to PROGRAM mode of operation.

From the Normal Display, press the  key until the following is visible:

```
SELECT    <->
FUNCTION SETUP
```

With FUNCTION shown in the lower display line, press the  key. The following will now be visible on the user display:

```
SELECT FUNCTION
STLR   SFLR   CPRC
```

Press the  key until STLR is flashing, then press the  key to select. On units that have ONLY the STLR function, STLR will NOT flash – simply press the  key to proceed. Available parameters are:

Parameter 1

STLR INPUT USAGE

Definition: This parameter selects NORMAL run mode, with a SIMULATED run mode option for demonstration purposes.

Default: NORMAL mode

Press  key to advance to next selection

Parameter 2

```
STLR INP TRANSMIT TO
CURRENT OUTPUT      X
```

Definition: This parameter allows a 4-20 mA output to be established for the main STLR input.

Default: User dependent

Press  key to advance to next selection

Parameter 3

STLR INPUT RECORDING

Definition: This parameter determines if the temperature from the Hot Product Probe input is printed to the chart, and if so, in which color.

Default: RED

Press  key to advance to next selection

Parameter 4

STLR INP DISPLAY OPT

Definition: This parameter, when active, will display the temperature inputs (Primary - Secondary) from the Hot Product Probe.

Default: IN BOTH MODES

Press  key to advance to next selection

Parameter 5

STLR INPUT DISPLAY BOTH

Note: This parameter is not shown if STLR INP DISPLAY OPT is set to NOT DISPLAYED.

Definition: If STLR Input is being displayed, this parameter selects whether both input 1 (Primary) and input 2 (Secondary) are displayed, or if only input 1 (Primary) is displayed.

Default: NO

Press  key to advance to next selection

Parameter 6

**STLR INP CORRECTION
.X°F**

Note: °C shown if unit set for Celsius

Definition: This parameter allows a correction factor to be added to the STLR Input Values. It is used to correct discrepancies between the actual temperature value, and the value that prints to the display/chart. See section 5.1.2 for further information.

Default: As necessary

Press  key to advance to next selection

Parameter 7

STLR OUT DISPLAY OPT

Definition: This parameter displays as ON or OFF on the user display. It is based on meeting the requirement of Diversion Setpoint + Deadband. May or may not indicate forward flow condition - dependent on presence of SFLR function.

Default: IN BOTH MODES

Press  key to advance to next selection

Parameter 8 STLR SP RECORDING

Definition: This parameter will determine if the STLR Diversion Setpoint is recorded to the chart, and if so, in which color. The factory default is GREEN.

Default: GREEN

Press  key to advance to next selection

Parameter 9 STLR SP DISPLAY OPT

Definition: This parameter, when active, will display the ***CURRENTLY ACTIVE*** Diversion Setpoint.

Default: User defined - Diversion Setpoint will record to chart even if this parameter set to OFF

This completes STLR program options. The remaining menu options are for non-STLR related functions. Press  to return to main display.

6.2. STLR Recorder Setup

Note: See section 3.2 to set unit to PROGRAM mode of operation.
From the Normal Display, press the  key until the following is visible:

SELECT <->
CONFIGURATION

Press the  key.

Press the  key until the following is visible:

CONFIGURE <->
RECORDING PENS

Press the  key.

Press  if STLR INPUT/EVENT is flashing, or else  until it is, then .

Parameter 1

STLR INP PEN TAG

Definition: This parameter allows printing of tag information for the STLR input to the chart.

Default: STLR INP

Press  key to advance to next selection

Parameter 2

STLR INP DECIMAL POSITION

Definition: Decimal position for STLR chart scales.

Default: 0

Press  key to advance to next selection

Parameter 3

STLR INP ZONE LOW

Definition: Starts STLR scale at inside of chart

Default: DIVISION 0

Press  key to advance to next selection

Parameter 4**STLR INP ZONE HIGH**

Definition: Ends STLR scale at outside of chart

Default: DIVISION 100

Press  key to advance to next selection

Parameter 5**STLR INP ZONE LOW**

Definition: Data for start of chart scale

Default: Depends on scale, typical = 120 °F

Press  key to advance to next selection

Parameter 6**STLR INP ZONE HIGH**

Definition: Data for end of chart scale

Default: Depends on scale, typical = 220 °F

Press  key to advance to next selection

Parameter 7**STLR INP INTERVAL**

Definition: Interval for scale printing

Default: Factory defined based on chart scale

Press  key to advance to next selection

Parameter 8**STLR INP ERROR POSITION**

Definition: Sensor fault / loss of input will drive pen to center of chart.

Default: Division 0

Press  key to advance to next selection

Parameter 9**RECORDER FUNCTION
STLR SETPOINT**

Definition: No input here - section heading

Press  key to advance to next selection

Parameter 10**STLR SP PEN TAG**

Definition: This parameter allows printing of tag information for the STLR Setpoint to the chart.

Default: STLR SP

Press  key to advance to next selection

Parameter 11**STLR SP DECIMAL POSITION**

Definition: Decimal position for STLR Setpoint chart scales.

Default: 0

Press  key to advance to next selection

Parameter 12**STLR SP ZONE LOW**

Definition: Starts STLR Setpoint scale at inside of chart

Default: DIVISION 0

Press  key to advance to next selection

Parameter 13**STLR SP ZONE HIGH**

Definition: Ends STLR Setpoint scale at outside of chart

Default: DIVISION 100

Press  key to advance to next selection

Parameter 14**STLR SP ZONE LOW**

Definition: Data for start of chart scale

Default: Automatically matches STLR chart scale

Press  key to advance to next selection

Parameter 15**STLR SP ZONE HIGH**

Definition: Data for end of chart scale

Default: Automatically matches STLR chart scale

Press  key to advance to next selection

Parameter 16**STLR SP INTERVAL**

Definition: Interval for scale printing

Default: Factory defined based on chart scale

Press  key to advance to next selection

Parameter 17**STLR INP ERROR POSITION**

Definition: Sensor fault / loss of input will drive pen to center of chart.

Default: Division 0

Press  key to advance to next selection

This completes STLR specific program parameters. Depending on model, additional parameters may be present under this menu. To return to the main display, press .

6.3. Chart Setup

Note: See section 3.2 to set unit to PROGRAM mode of operation.

Press the  key once.

Press the  key once.

Parameter 1

CHART TAG

Definition: Tag information to print on outer chart ring

Default: Per customer order

Press  key to advance to next selection

Parameter 2

CHART SPEED

Definition: Rotation time for 1 revolution

Default: 12 hour (Per PMO) for Legal Pasteurization

Press  key to advance to next selection

Parameter 3

MAJOR TIME PERIODS

Definition: Major scale divisions

Default: 12 - results in 1 major per hour

Press  key to advance to next selection

Parameter 4

MINOR TIME PERIODS

Definition: Scale divisions printed between each major

Default: 4 - results in 15 minute chart divisions

Press  key to advance to next selection

Parameter 5

BLANK MAJOR PERIODS

Definition: Allows major printing without scale information.

Default: 0

Press  key to advance to next selection

Parameter 6

MAJOR LINE PEN COLOR

Definition: Selects scale pen color

Default: Match Scale Color

Press  key to advance to next selection

Parameter 7

MINOR LINE PEN COLOR

Definition: Selects scale pen color

Default: Match Scale Color

Press  key to advance to next selection

Parameter 8

TIME PEN/COLOR

Definition: Color for time on chart outer ring

Default: User definable

Press  key to advance to next selection

Parameter 9

DATE PEN/COLOR

Definition: Color for date on chart outer ring

Default: User definable

Press  key to advance to next selection

Parameter 10

CHART TAG PEN/COLOR

Definition: Color for tag on chart outer ring

Default: User definable

Press  key to advance to next selection

Parameter 11

ACTION ON NEW CHART

Definition: Defines action following NEW chart command.

Default: NONE – JUST CONTINUE

Press  key to advance to next selection

This completes STLR specific program parameters. To return to the main display, press .

7. RUN Mode Parameter Changes

Many parameters are available to the user during the RUN mode of the AV-9900. The following flow-charts illustrate the key sequences used to access parameters.

NOTE: All parameters termed critical, as outlined in section 6.0, are NOT accessible while in the RUN mode.

7.1. Chart Key

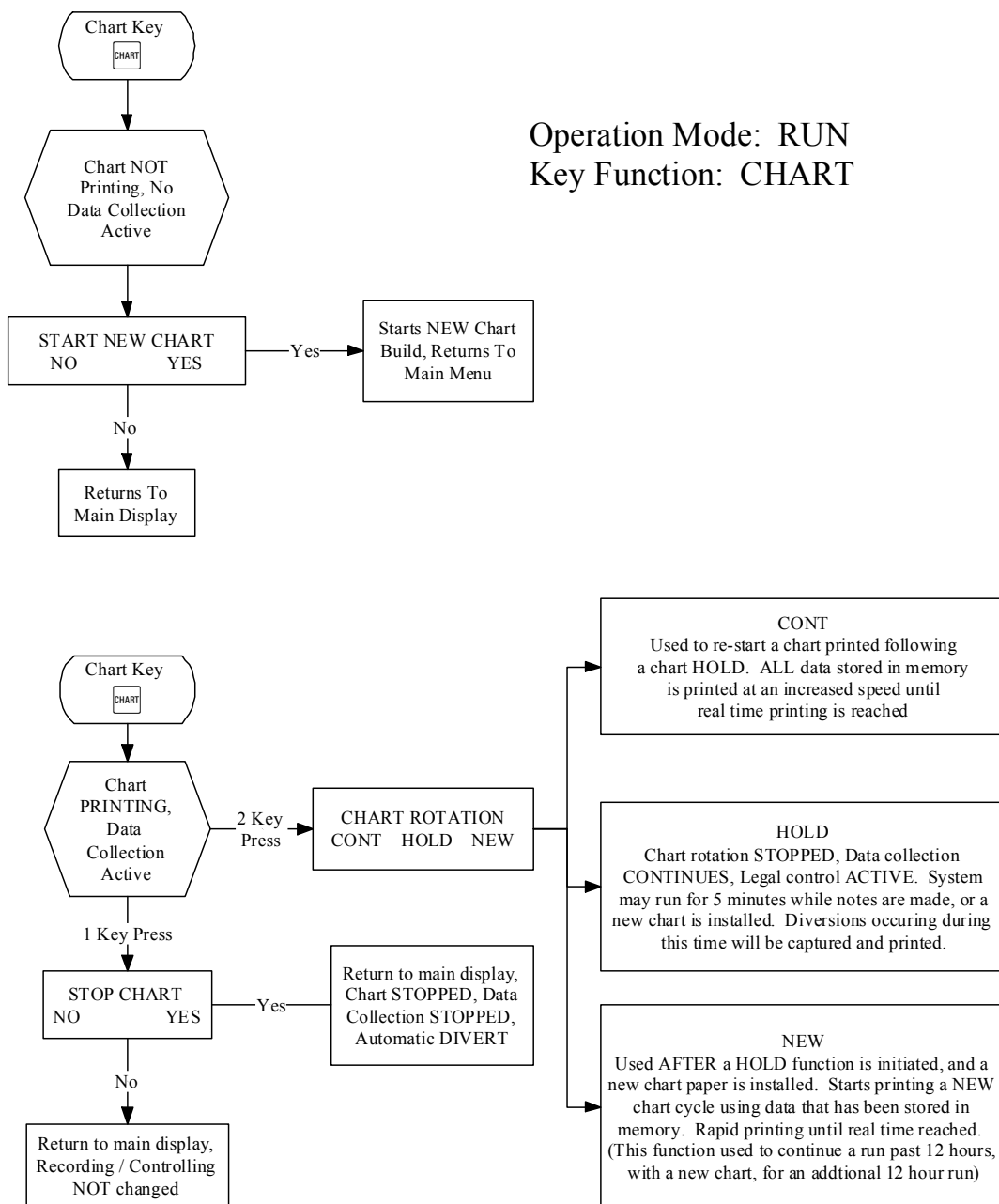

7.2. Display Key

Operation Mode: RUN
Key Function: DISP

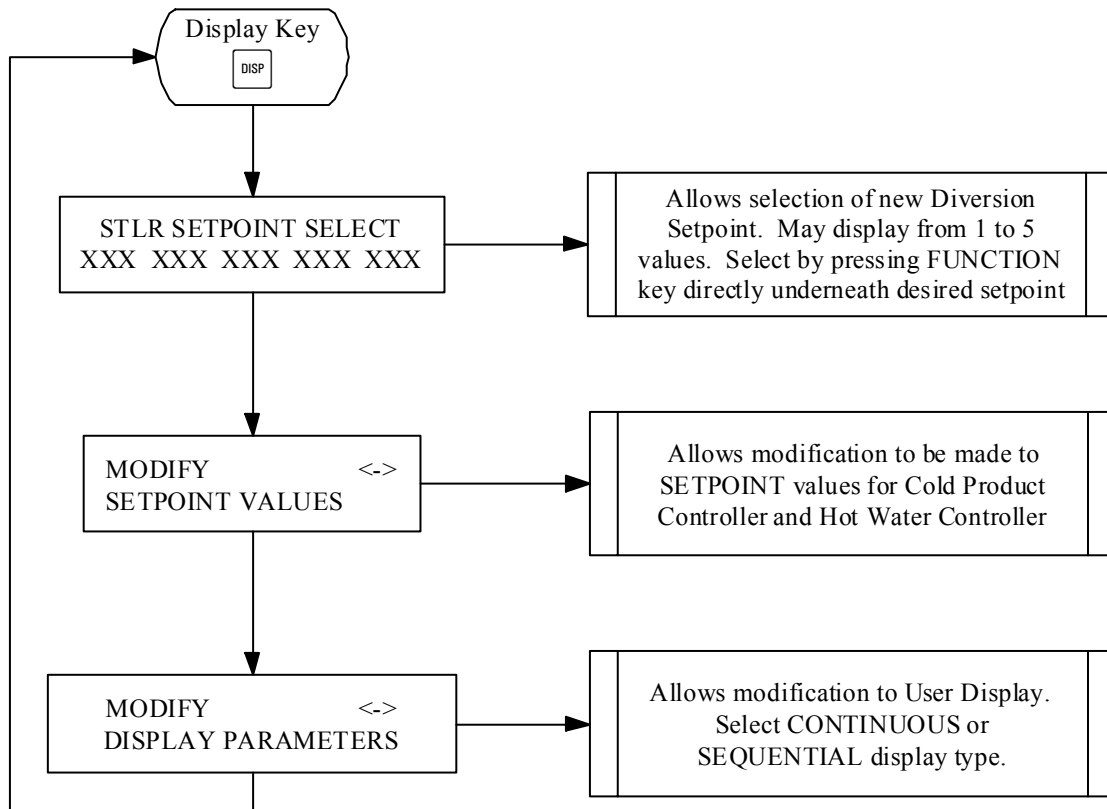

7.3. Scroll Key

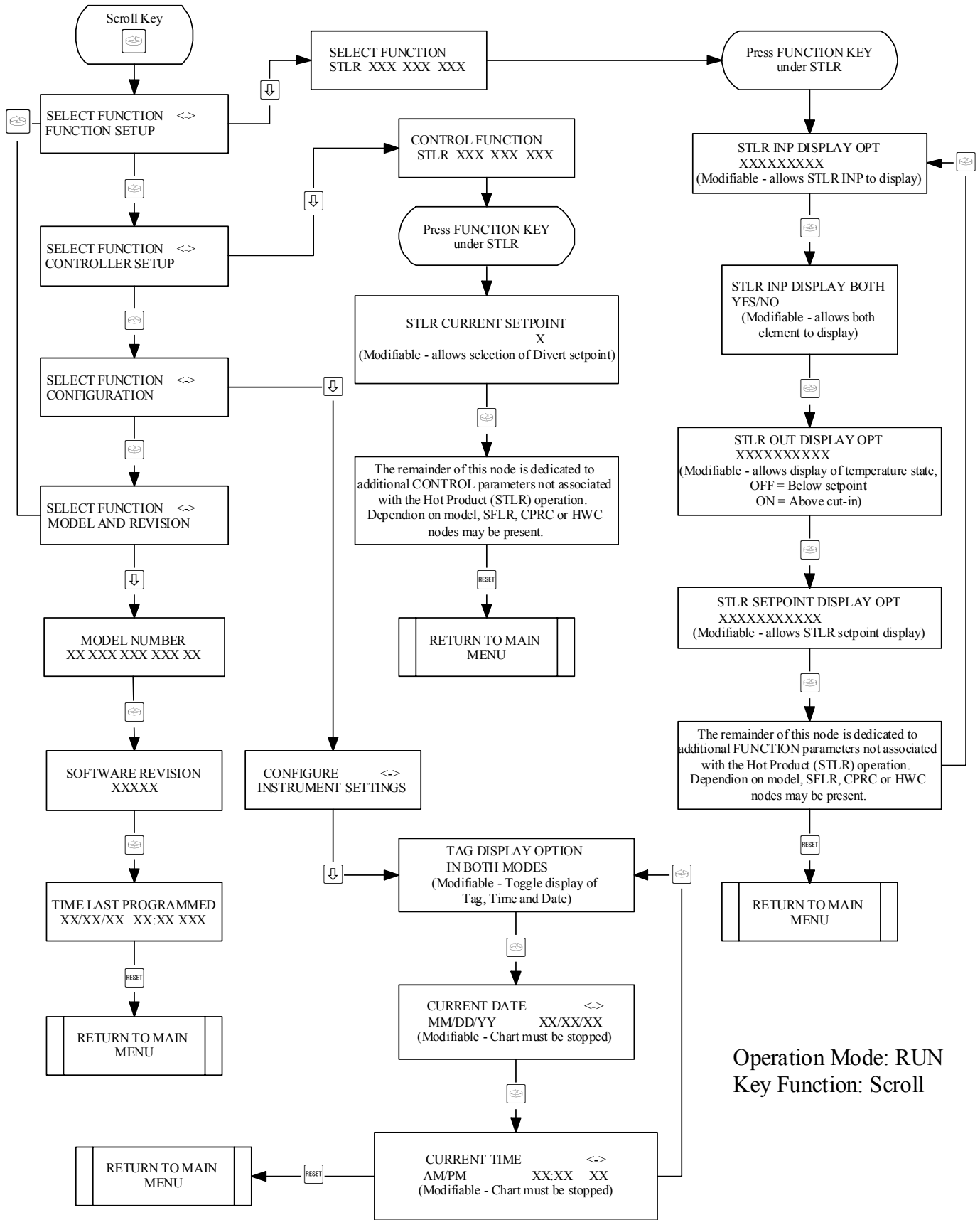

Operation Mode: RUN
Key Function: Scroll

For questions, please contact:

**Anderson Instrument Inc.
Technical Services Department**

Phone: 800-833-0081

Hours of operation 8:00 am to 5:00 pm EST
24 hour emergency voice response available